

◆ Main Specifications

Working Voltage	24 (V DC)
DC Resistance	20 (Ω)
External Resistance	15 (Ω) <4 (W) or more>
Duty Cycle	20 (%) or less
Max ON Time	40 (ms)
Coil Saturation Temperature Rise $\Delta\theta_s$ (at 20°C)	$\Delta\theta_s \doteq 12 \times W$ (°C) $K \doteq 12$ (°C/watt)
Temperature Rise Time Constant τ	9 (minutes)
Heat-Resistant Class	Class E (120°C)
Insulation Resistance	500V DC MEGA, 100M Ω or more
Dielectric Strength	1000V AC, 50/60 Hz, 1 minute
Mass	120 (g)
Non-Excited Holding Force	10 (N) or more
Response Speed *1	20 (ms)

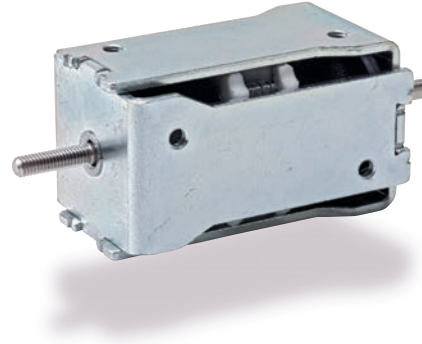

* 1: measurement conditions: measured by Takano Co. in a standard testing environment, with no load, shaft in a horizontal position, applied voltage 24V DC.

◆ Attractive Force Data

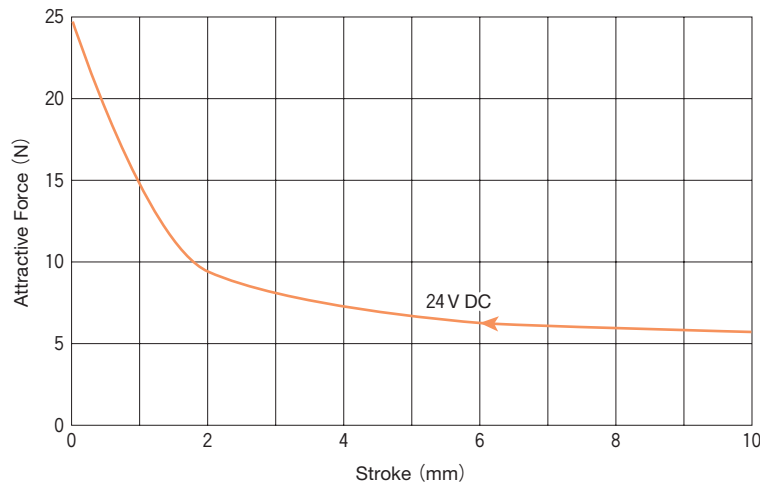

◆ External Dimensions (mm)

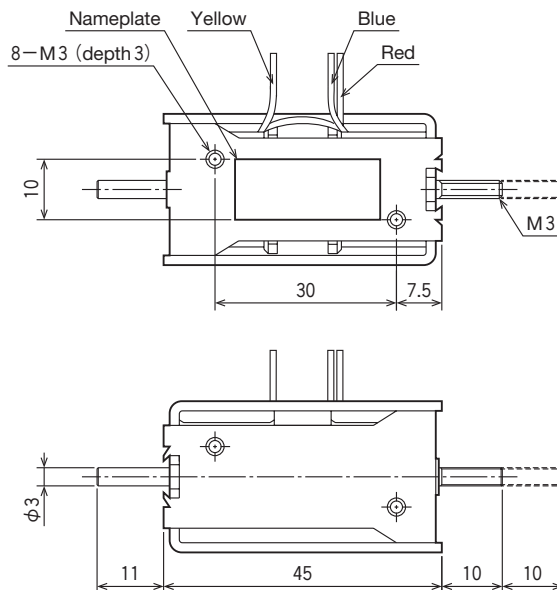

Terminal Specifications

Lead Wire Length (mm) : 210
AWG Size : 26